

Adsorber VM-R series

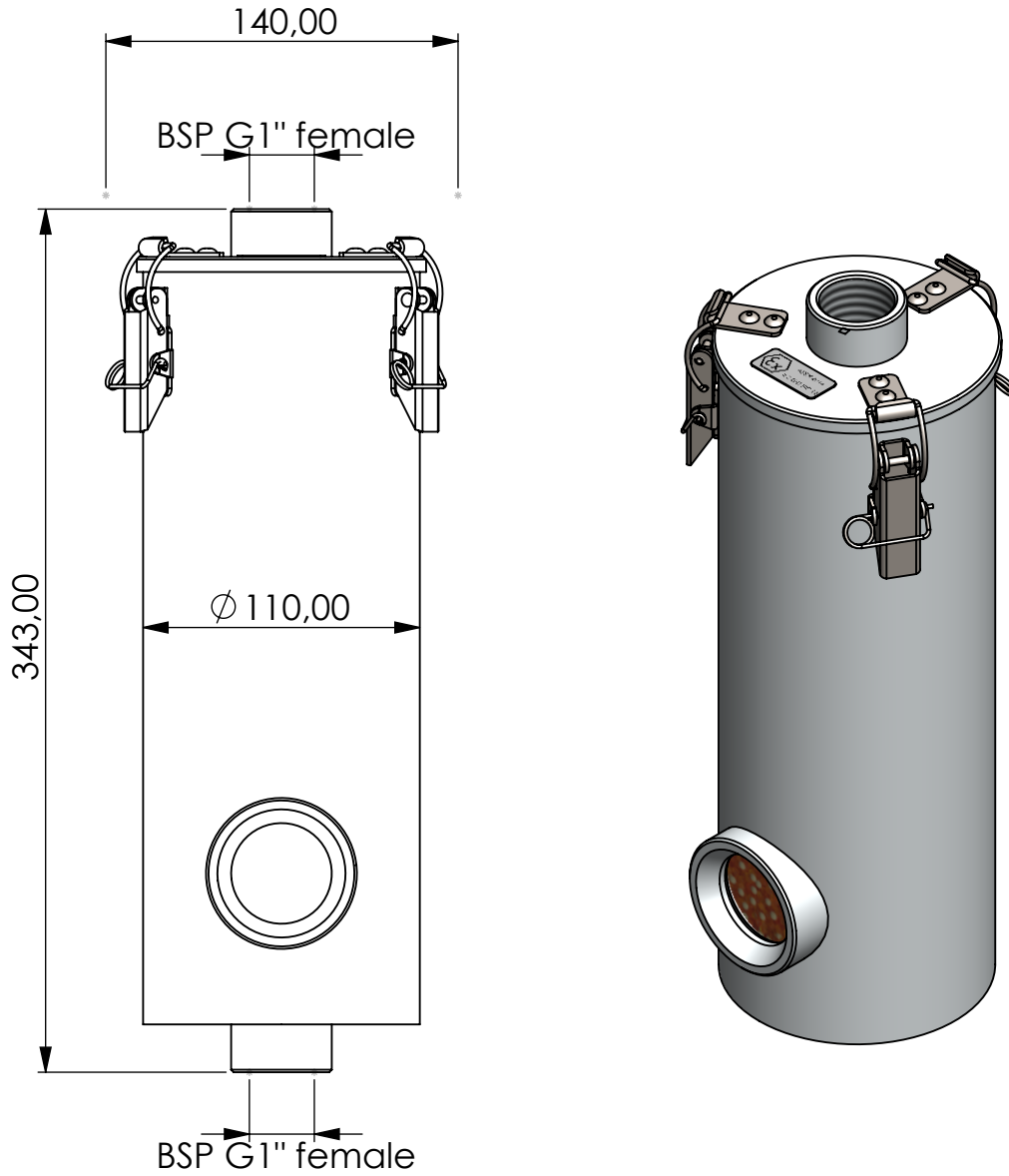

Product Code	VM	-	R	-	3L	-	F	-	V2	-	X	-	G1f	-	G1f
	Adsorber type		Refillable cartridge		Size		FKM seals		Fleece filter 2 micron		Adsorbent GIEBEL Xdry®		Connection for System BSP G1" female		Connection for System BSP G1" female

Housing materials: AL	
GIEBEL Xdry® (kg): 1.8	Color-change capacity (ml): 630
Total weight (kg): 3.3	
NAME:	
Adsorber VM-R 3L G1" f	
VM-R_3L_F_V2_X_G1f_G1f	
Article no.:	Status approved
12.0000.34	Format A4
	Ratio 1:3
	Sheet / of 1 / 1

	Date	Name
rev.	24.05.2024	Daniel Zinic
 GIEBEL Adsorber® ...setting standards in aeration drying!		
GIEBEL FilTec GmbH www.giebel-adsorber.com info@gf-dry.com		