

Adsorber VV-R series

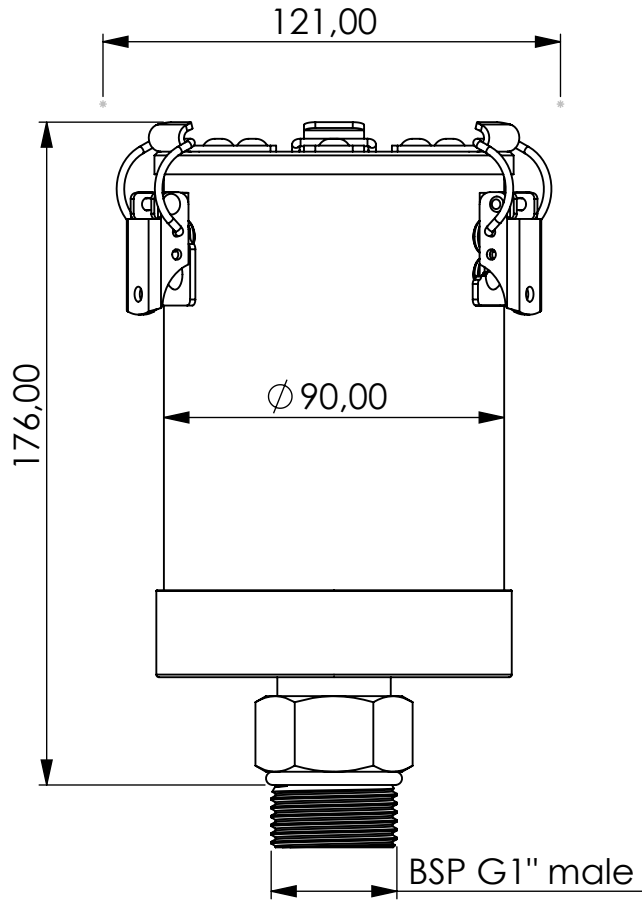

Product Code	VV	-	R	-	2M	-	F	-	00	-	P3	-	XC	-	G1m
	Adsorber type		Refillable cartridge		Size		FKM seals		No valves 0 IN 0 OUT		Paper filter 3 micron		Adsorbent GIEBEL Xdry® & carbon		Connection for System BSP G1" male

Housing materials:	PA6, PC, AL	
GIEBEL Xdry® (kg):	0,3	Color-change capacity (ml): 105
Total weight (kg):	0.91	

NAME:		
Adsorber VV-R 2M G1"m		
VV-R_2M_F_00_P3_XC_G1m		
Article no.:	Status freigabe	Format A4
05.0020.56	Maßstab	Blatt / von
	1:2	1 / 1

	Date	Name
rev.	17.04.2023	Daniel Zinic
 GIEBEL Adsorber® ...setting standards in aeration drying!		
GIEBEL FilTec GmbH www.giebel-adsorber.de info@giebel-adsorber.de		