

# Ventilation System EBS

accessory

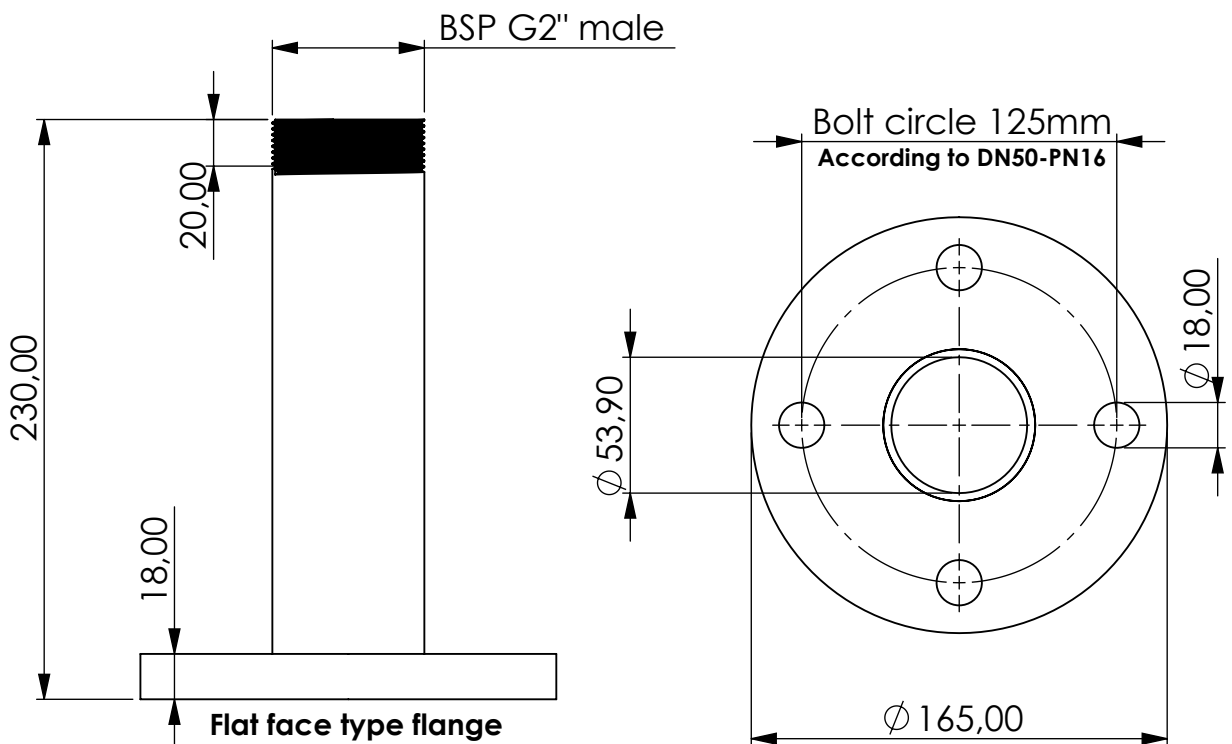
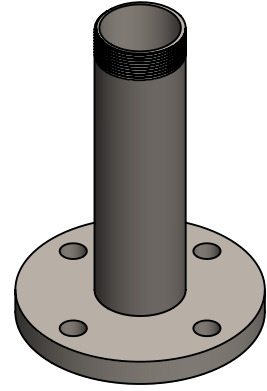

Product Code	<b>EBS</b>	-	<b>FBG</b>	-	<b>SS</b>	-	<b>DN50</b>	-	<b>PN16</b>	-	<b>G2a</b>
	Ventilation System EBS		Flange assembly		Material stainless steel 316L		DN50 flange		PN16 pressure rating		Connection for EBS BSP G2" male

Total weight (kg): 3.559

NAME:

**Ventilation System EBS accessory**  
EBS-FBG\_SS\_DN50\_PN16\_G2a

Article no.:

**08.2349.01**

Status approved

Format A4

Ratio 1:3

Sheet / of 1 / 1



**GIEBEL Adsorber®**  
...setting standards in aeration drying!

GIEBEL FilTec GmbH  
www.giebel-adsorber.com  
info@gf-dry.com